

DRAGON FORCES

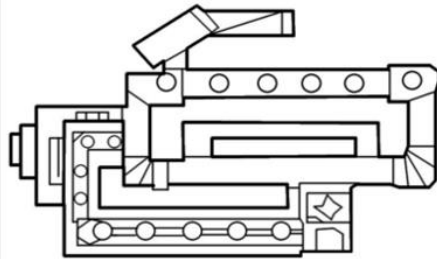

**Mortal
Canon
Multistriker**

Weapon Price  **500** 

4.5 b/s  Firing rate

Firepower  **8 M**

This weapon will shoot a lethal burst of canon balls. It will never run out of supplies.

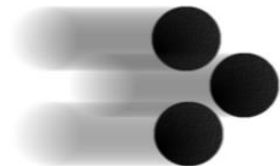

CEREVROVI 

DRAGON FORCES



Waldorf The Magician

Weapon Price  800 

Super Bonus  Firing rate

Firepower  8 M

Waldorf The Magician will help you through the most dangerous levels. Anytime you feel dispair, he will come and settle things, using his special spells.

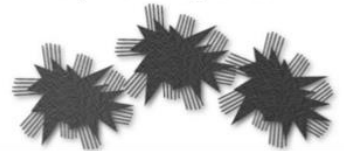

CEREVROVI 

DRAGON FORCES

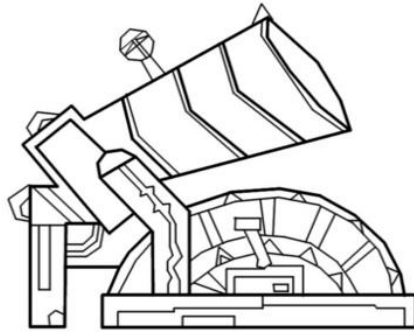

Multiangle Lethal Netshooter

Weapon Price  700 

3.5 b/s  Firing rate

Firepower  5 M

This weapon has a multiangle shooter that can allow you to shoot nets to earth and air dragons.

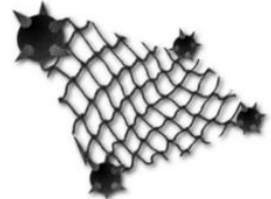

CEREVROVI 

**DRAGON
FORCES**

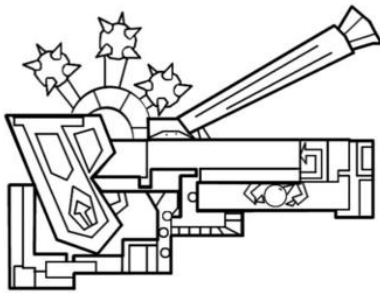

**Freaky
Pointball
Multishooter**

Weapon Price  **200** g

4 b/s  **Firing rate**

Firepower  **7** M

This weapon has an
intern special
machinery that
creates giant steel
peak-bullets.

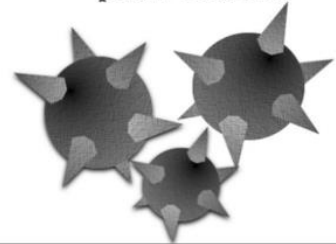

CEREVROVI 

DRAGON FORCES

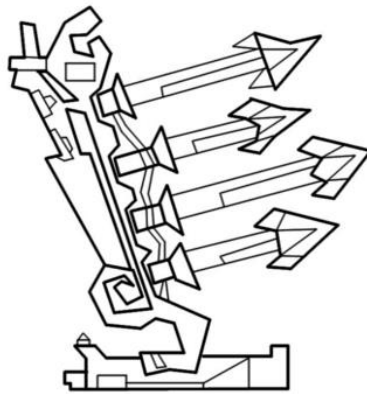

**Poison
Machinery
Bow n' arrows**

Weapon Price  **600** 

2 b/s  **Firing rate**

Firepower  **4 M**

This mortal bow will shoot multiple types of arrows, each one has a different mortal anti-dragon poison.



CEREVROVI 

DRAGON FORCES

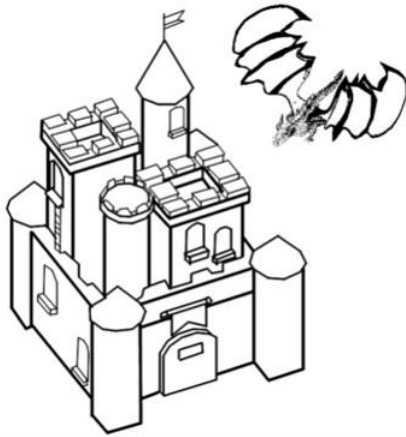

Vento du Bred Castles

"The Great Northern Lands"



"Archfael"

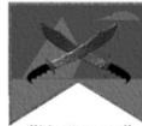

"Iodocus"



"Drust Cagernd"



"Erk Olth"

There are four different castles. Together, they form the best defense against any invasion. They are the guardians of the Vento Du Bred Kingdom.



CEREVROVI